

**LA SALUD COMO ARGUMENTO DE PROYECTO
MÓDULO MEDICO PRE FABRIRCADO PARA LA
REGION DEL MAULE**

SOLO USO ACADÉMICO



↔ BALMACEDA

ZARAGOZA

VJEL A EL
ARRYAN
CALLE ZARAGOZA

ENTRADA →

SOLO USO ACADÉMICO

Saturación

SOLO USO ACADÉMICO

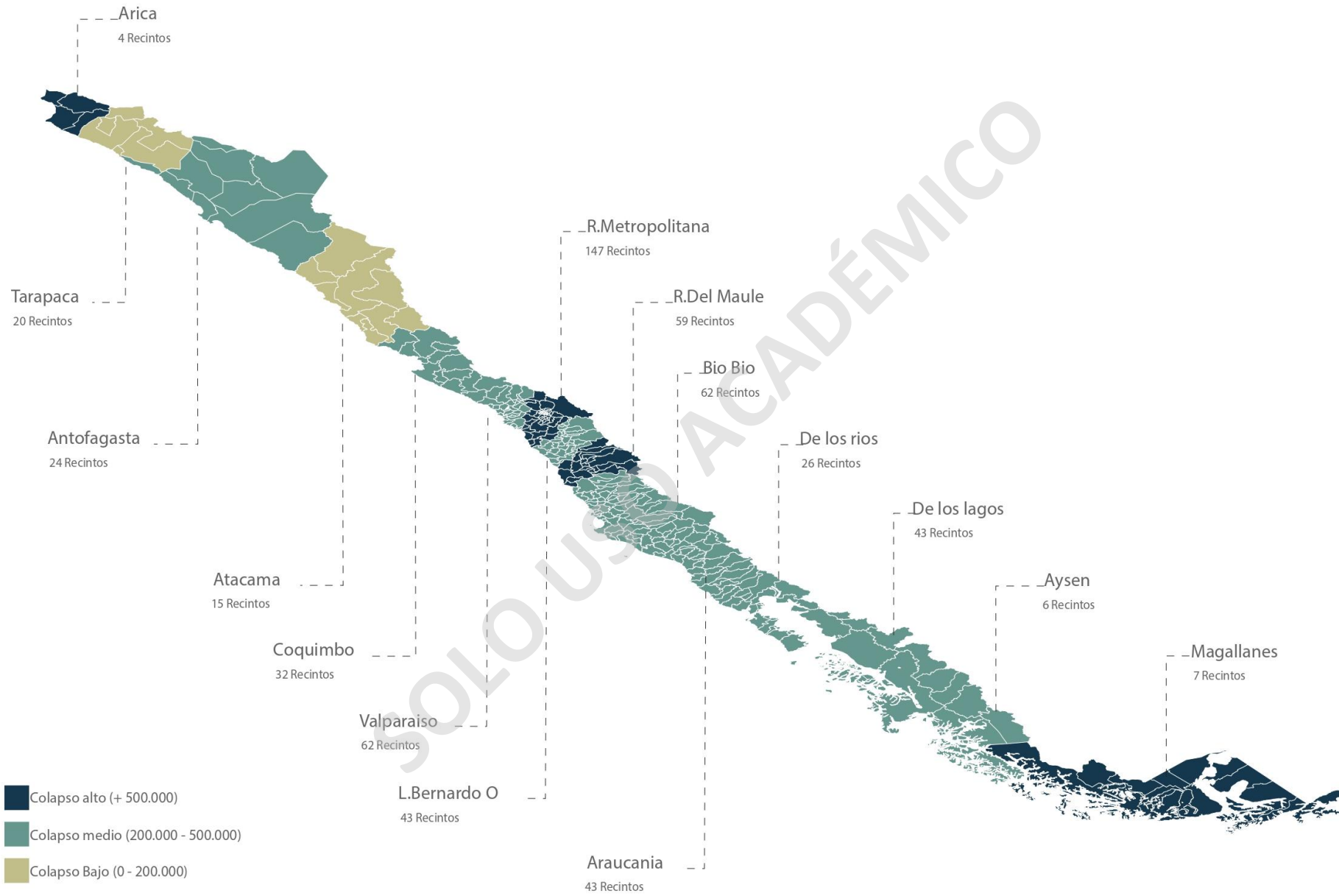

Desconexión

SOLO USO ACADÉMICO

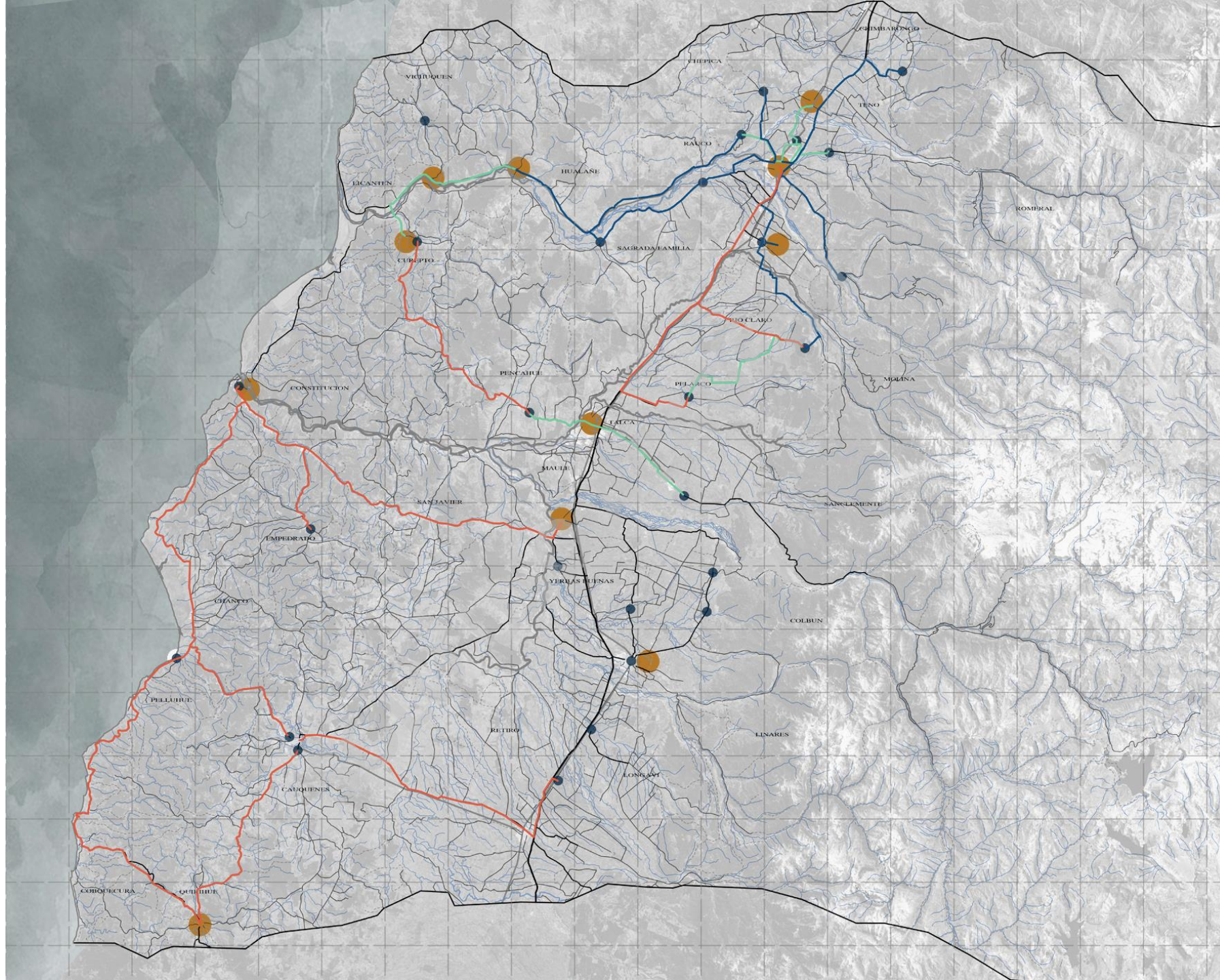

- CESFAM
- HOSPITAL
- + 1 HORA
- 30 MINUTOS
- + 30 MINUTOS

Deficiencia

SOLO USO ACADÉMICO





¿Qué tipo de proyecto arquitectónico aporte a descongestionar y proporcione un espacio adecuado para resolver las necesidades requeridas hoy en día en los servicios de atención médica que no se ven resueltos por los servicios de salud público?

¿Qué tipo de proyecto podría ubicarse en zona rurales de manera indefinida acortando tiempos de traslado y distancia?

Lugar

SOLO USO ACADÉMICO

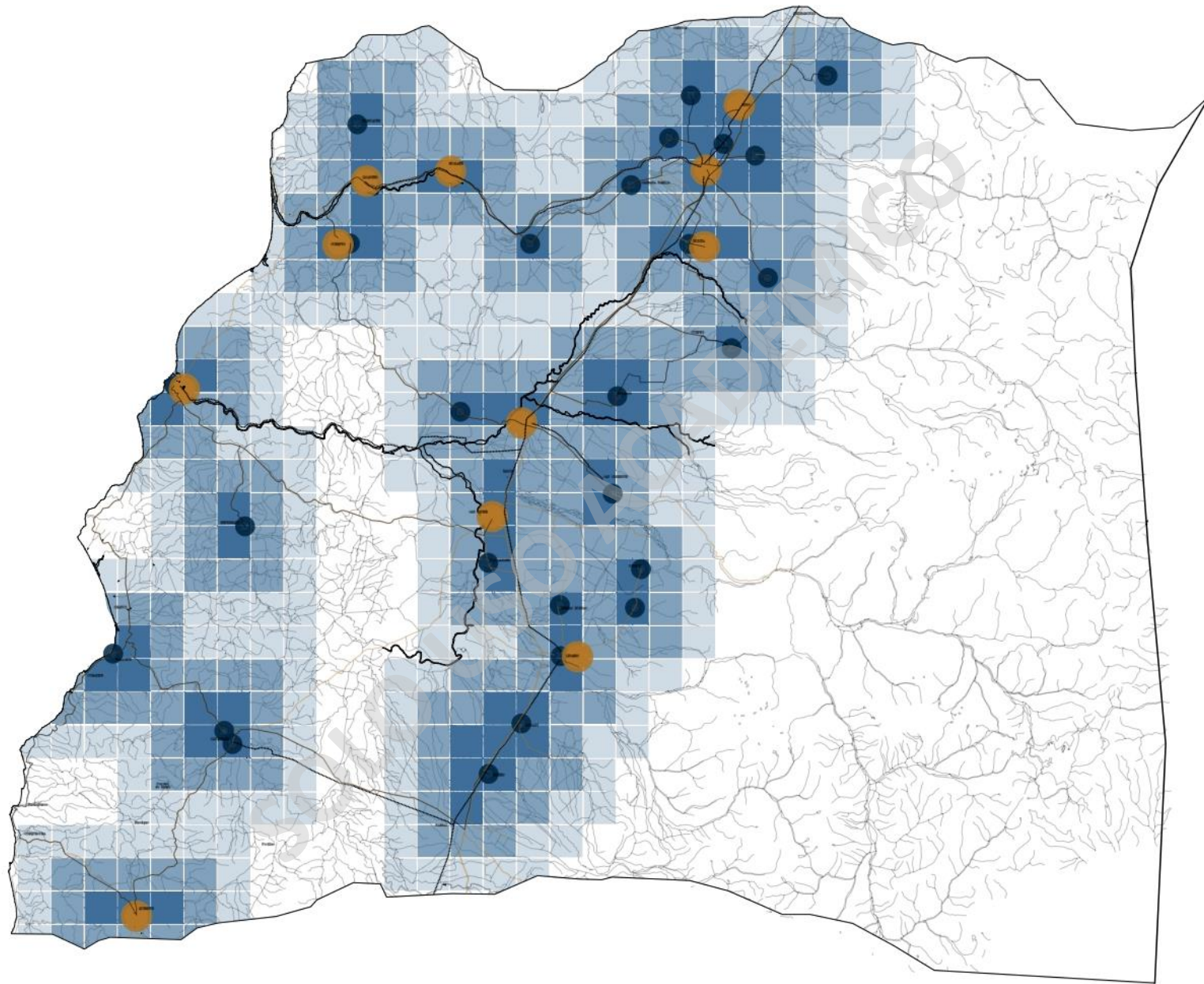

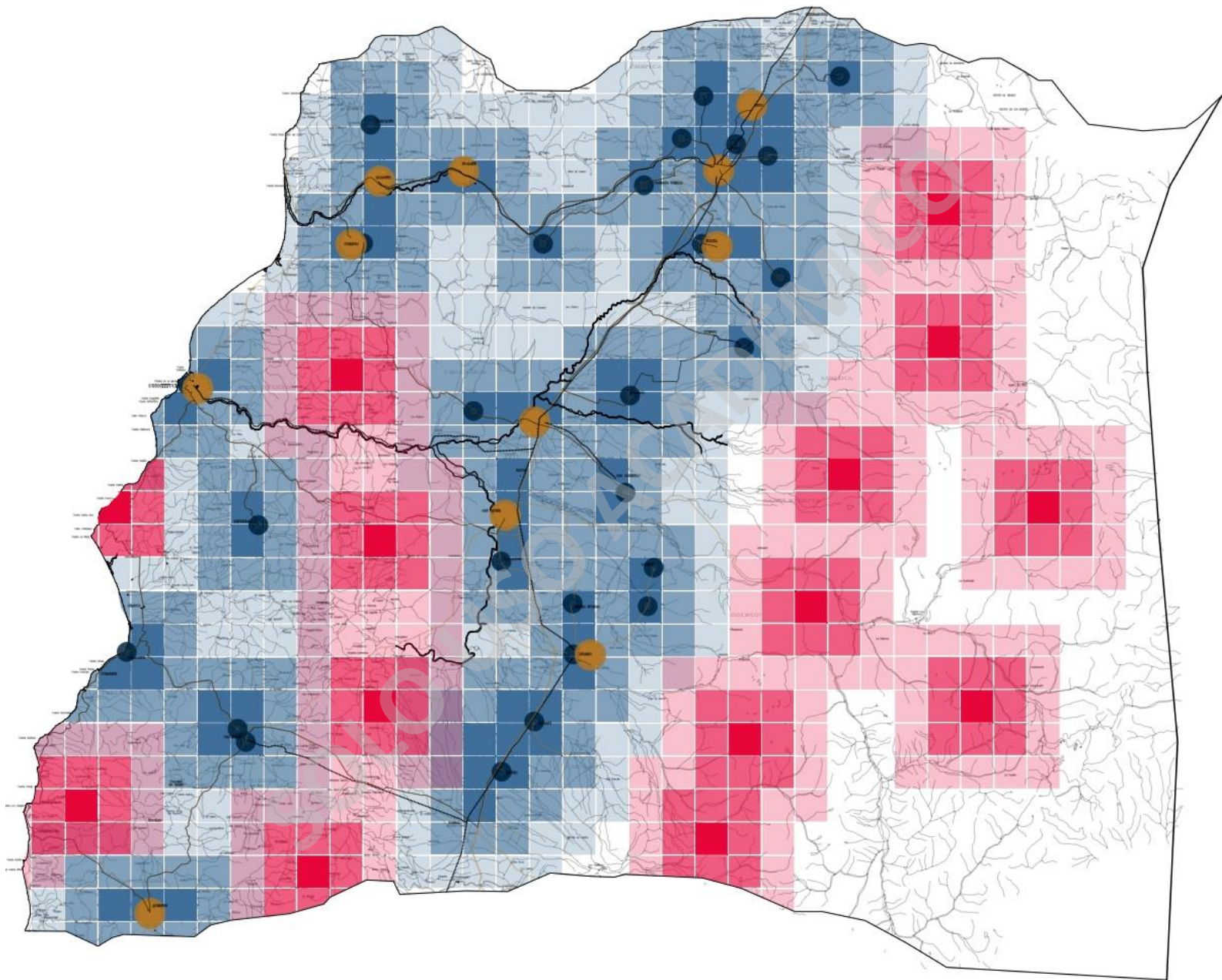

Lugares con servicios médicos y alcance

Ubicación de proyecto

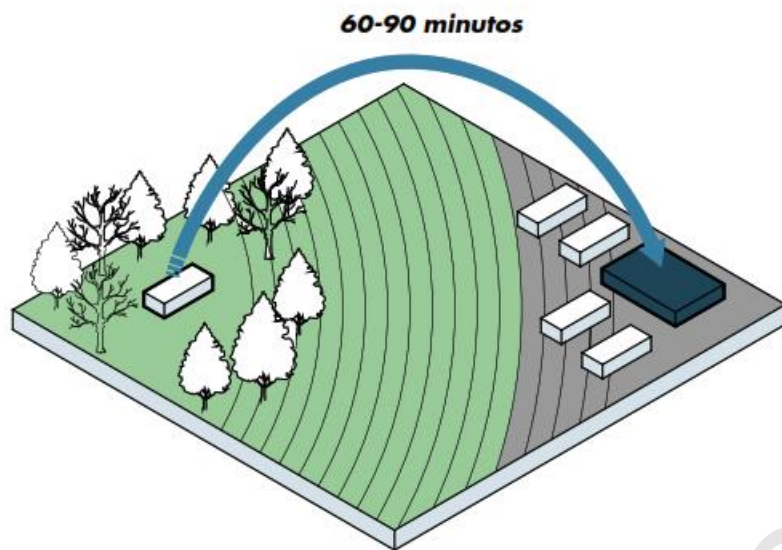

Desconexión de servicios

La desconexión de los servicios médicos que se concentran todos en las ciudades de la región haciendo que la población de sector rural tenga que movilizarse largos tramos tanto para consultas como en urgencias.

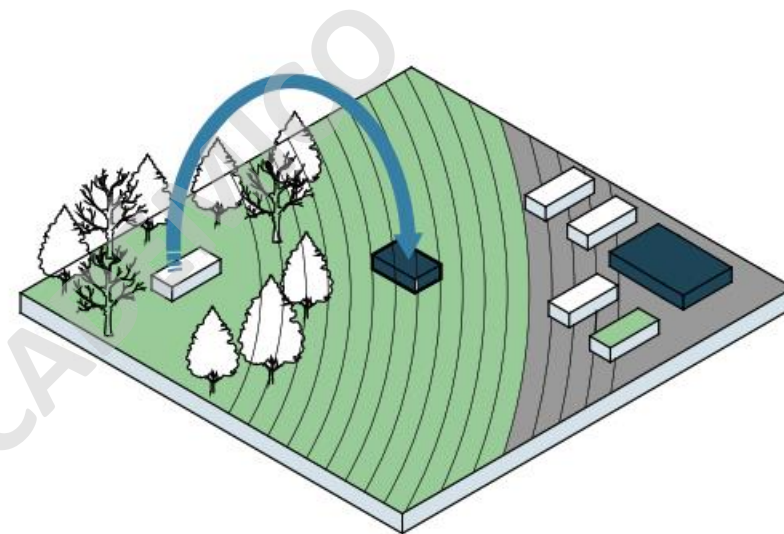

Aplicación del módulo

El módulo propone una disminución de la trayectoria y una disminución del tiempo para la población además de poder controlar tratamientos y descongestionar los sistemas de salud ubicados en otros sectores

Estrategia

SOLO USO ACADÉMICO

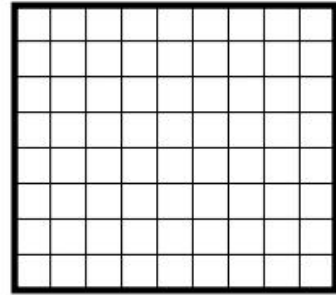
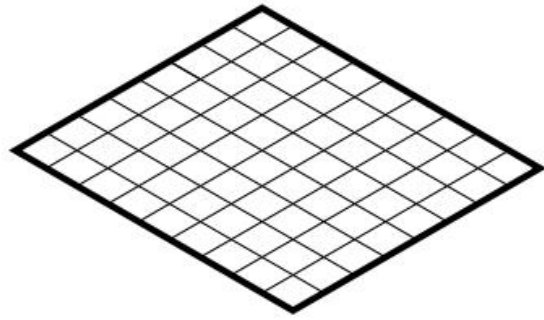

Grilla

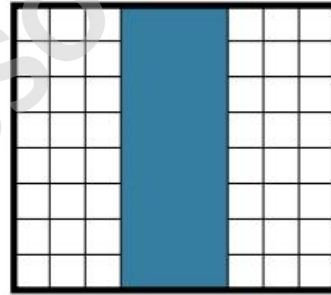
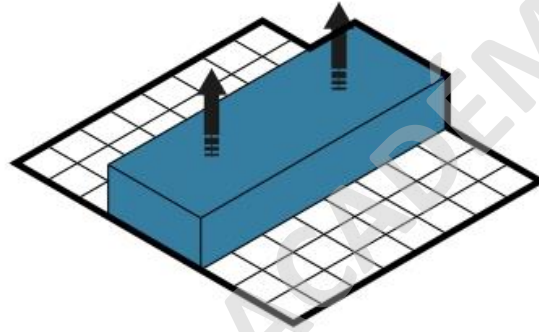

Modulo articulador

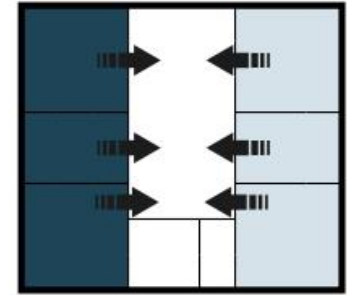
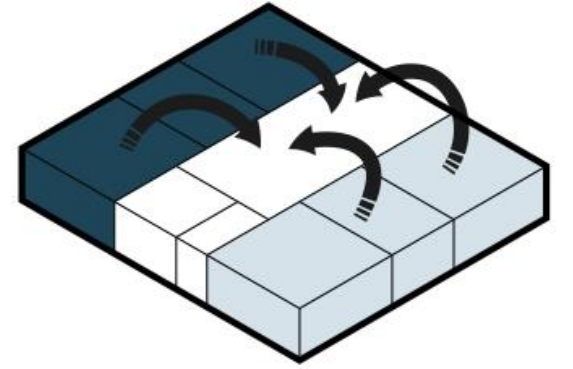

Programas vinculados

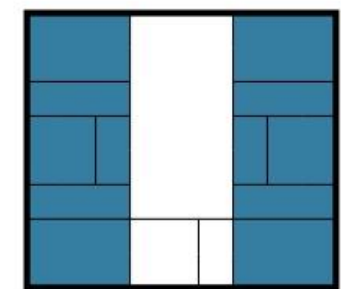
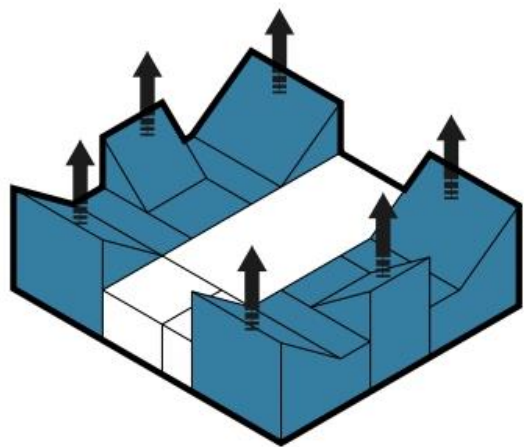

Levantamiento cubierta

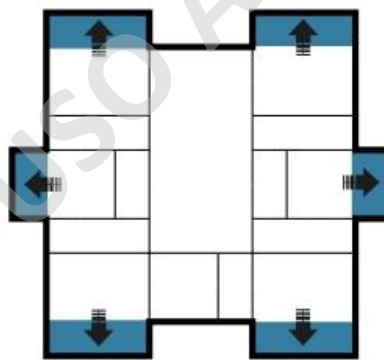
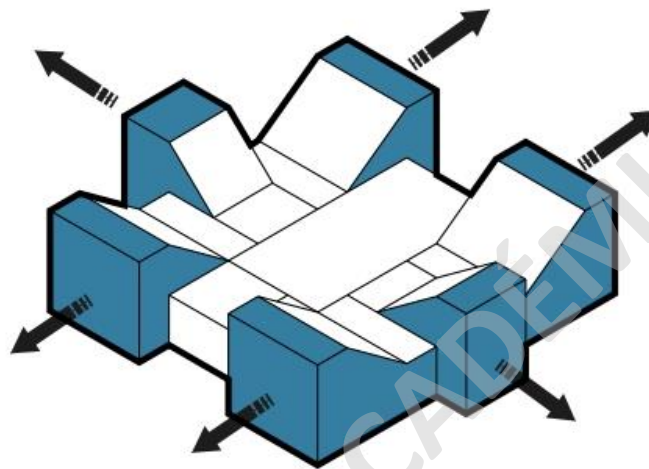

extruccion de modulo

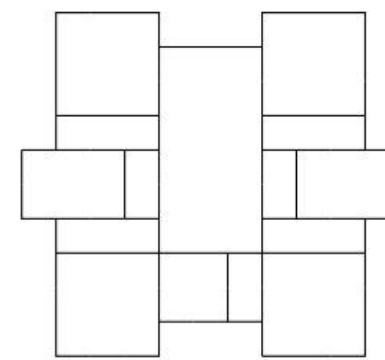
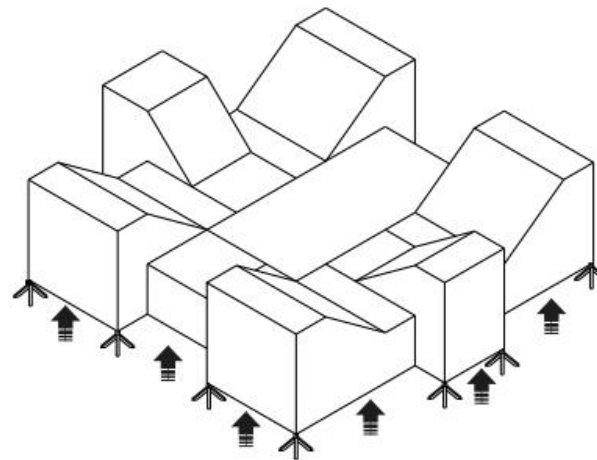

Llegada al suelo

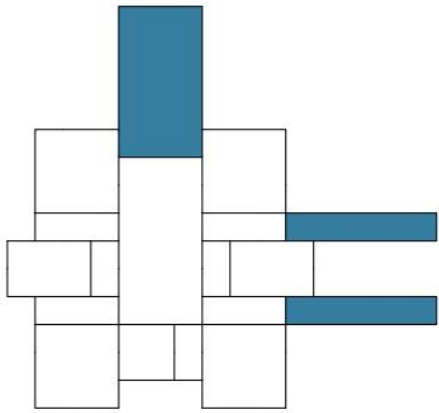
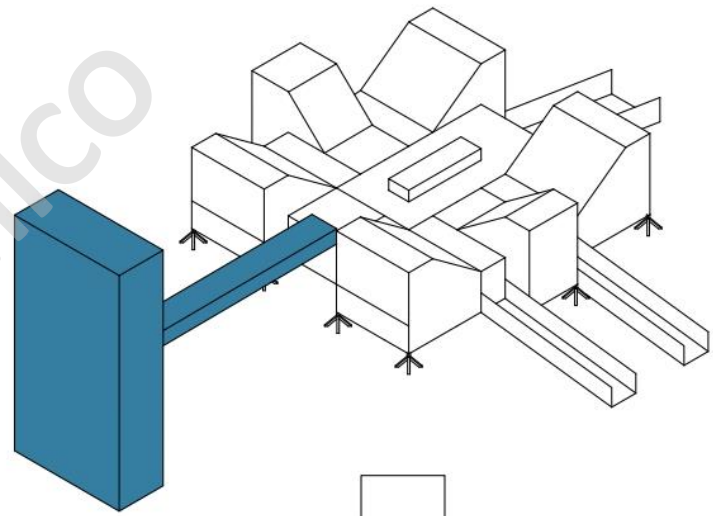
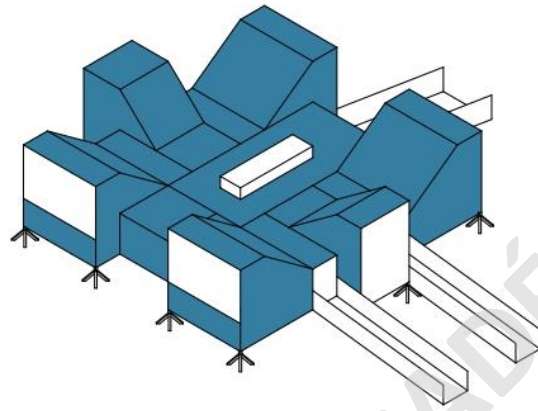
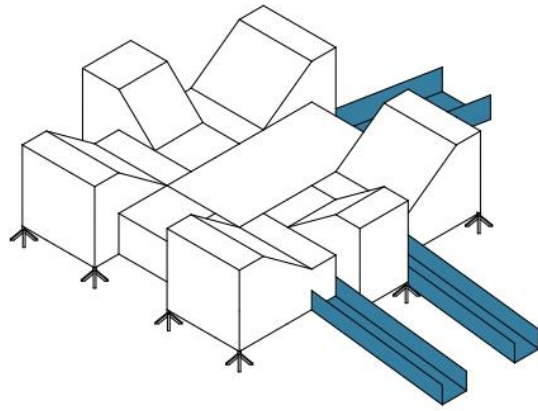

Rampa de acceso

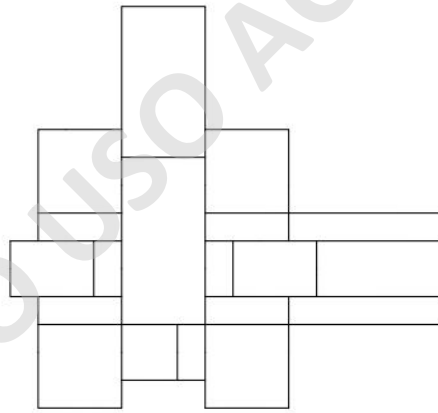

Revestimiento

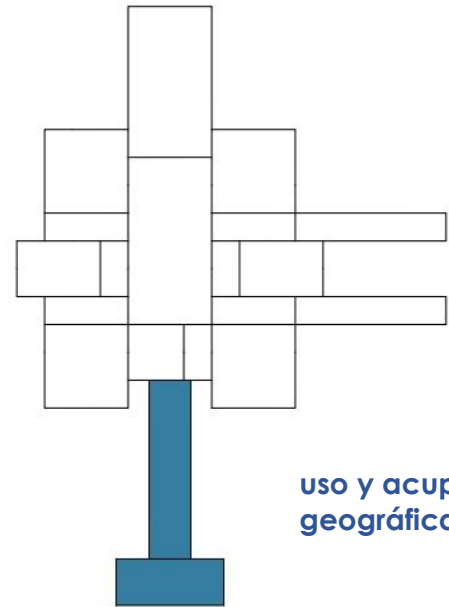

uso y acupuntura geográfica

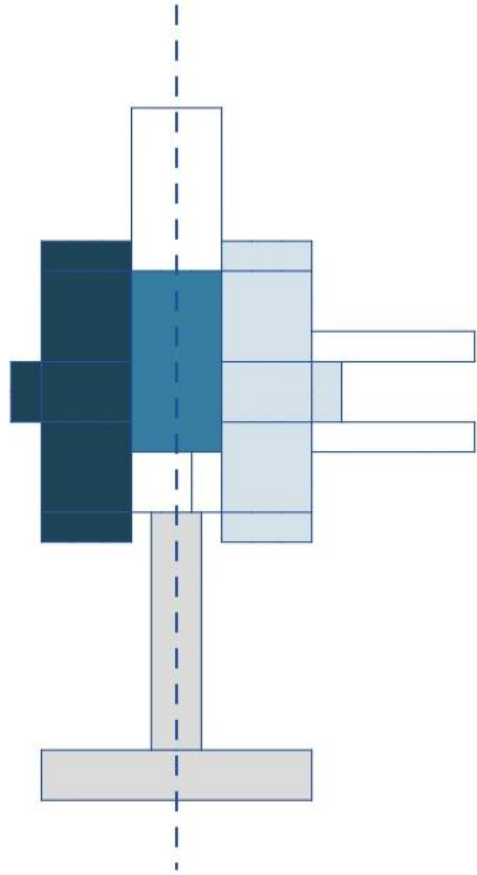

Uso técnico

Emergencia

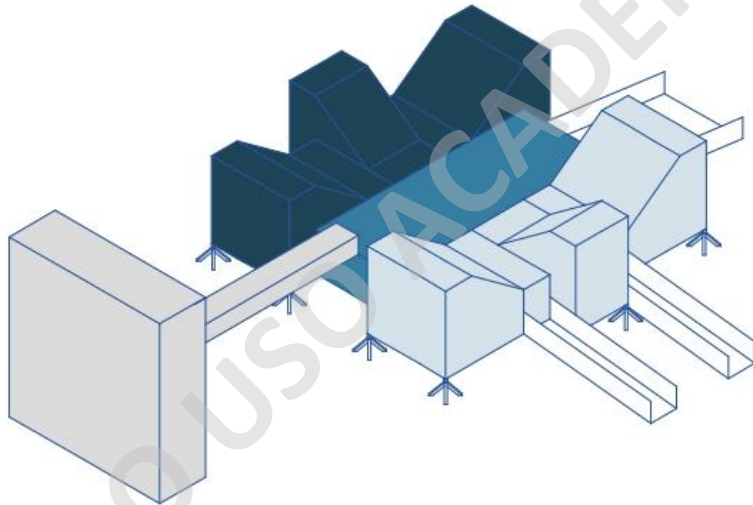

Recepción, Sala espera



Toma de muestras, Sala de yeso, Dentista



Procedimiento, Sala HIDRO, Sala ERA



Torre abastecimiento



Psicología



Sala descanso



Baño

Transporte

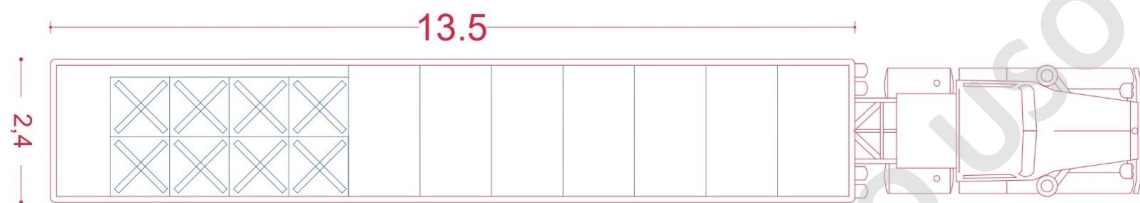
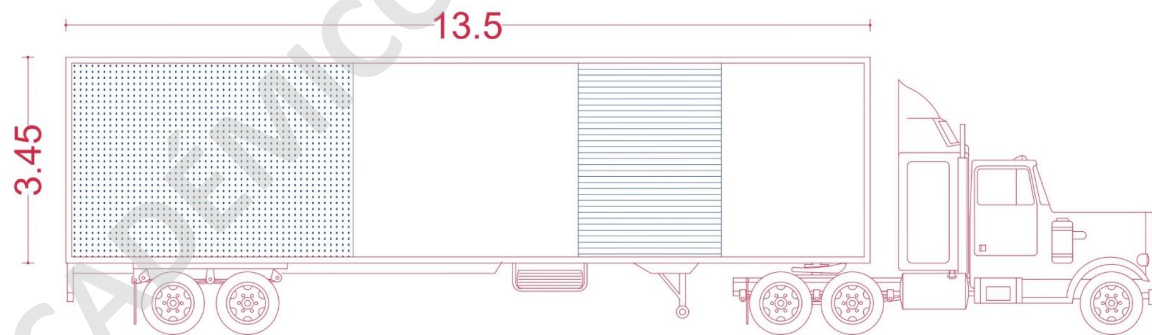

SOLO USO ACADÉMICO